

SP05

Specifications

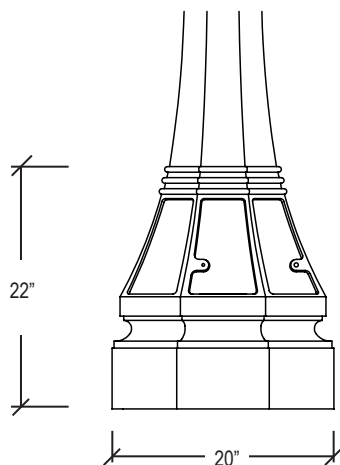

Front View

Bolt circle: 16"
Anchor bolts: four 24"L x 3/4"OD
Hook: 3"
Projection: 3"

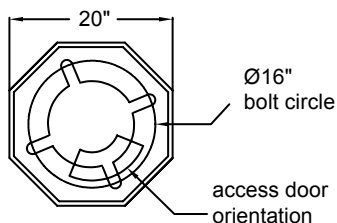

Bottom View

The SP05 series pole shall consist of a cast aluminum base and a shaft. The one-piece octagonal base shall be welded to the octagonal shaft. The base shall include a cast aluminum door. All castings shall be formed true to pattern, with no warping or mold shifting.

Unless specified otherwise, all poles ship with four anchor bolts, with two nuts and two washers per bolt and with one steel template for every three poles.

The shaft shall include a $\varnothing 3$ "OD or $\varnothing 4$ " x 3"H tenon for luminaire mounting. All exposed metal parts shall receive baked-on smooth semi-gloss powder coat finish. Poles ship loose, with doors and tenons pre-assembled, all wrapped in a protective layer of paper, cardboard and shrink wrap.

SP05

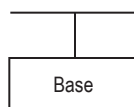

Base

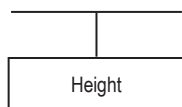

Height

8 - 8' overall height
10 - 10' overall height
12 - 12' overall height
16 - 16' overall height

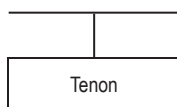

Tenon

A - 3"OD x 3"H (standard)
B - 4"OD x 3"H
X - non-standard (indicate size)

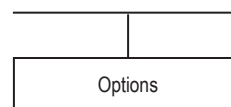

Options

GFI - GFI receptacle
LAB - less anchor bolts
FLG - flag holder

Banner arms - see "Accessories" at the end of the catalog

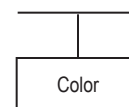

Color

BLK - black
GRN - green
BRZ - bronze
GRY - grey
WHT - white
CTM - custom

Suggested luminaire and bracket styles

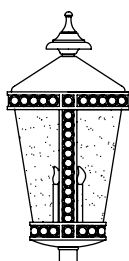

SH40

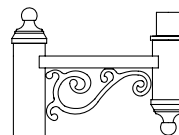

SA01-A

Sheridan
 lighting systems, inc.