

# SH15

# Specifications

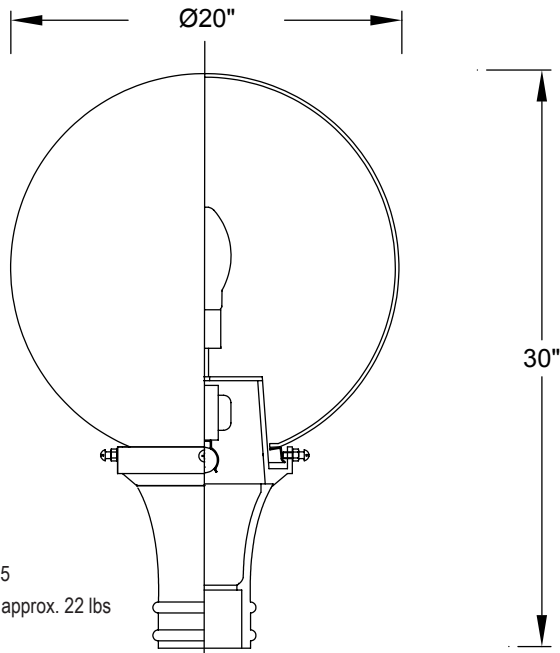

EPA: 1.55  
Weight: approx. 22 lbs





The SH15 series luminaire shall consist of a diffuser, a capital, a ballast assembly and an internal optical system. The spherical diffuser shall be injection molded, smooth acrylic or polycarbonate. The diffuser shall be secured to the cast aluminum capital with stainless steel hardware or with a quarter turn locking mechanism. All castings shall be formed true to pattern, with no warping or mold shifting.

The electrical and optical components shall be mounted on a cast aluminum ballast plate within the capital. The medium or mogul porcelain socket shall be 4kV pulse rated. The HID ballast shall be HPF, CWA, multi-tap, supplied with capacitor and ignitor. Luminaire shall be ETL certified as suitable for wet locations. Lamps by others.

The optical assembly shall be mechanically secured to the ballast plate.

The luminaire shall mount to a 3"OD or 4"OD x 3"H tenon with three sets of two stainless steel tamper resistant screws. All exposed metal parts shall receive baked-on smooth semi-gloss powder coat finish. Ships boxed and palletized.

## SH15

Luminaire	Size	Diffuser	Capital	Ballast	Voltage	Optics	Options	Color
	<b>L</b> - large 20"OD	<b>CA</b> clear acrylic	 <b>B</b> 11" H	<b>5M</b> - 50MH <b>7M</b> - 70MH <b>10M</b> - 100MH <b>15M</b> - 150MH <b>17M</b> - 175MH <b>25M</b> - 250MH	<b>1</b> - 120V	<b>BA</b> - bare lamp	<b>HS</b> - house side shield	<b>BLK</b> - black
	<b>M</b> - medium 18"OD	<b>WA</b> white acrylic	 <b>D</b> 8" H	<b>5H</b> - 50HPS <b>7H</b> - 70HPS <b>10H</b> - 100HPS <b>15H</b> - 150HPS <b>25H</b> - 250HPS	<b>2</b> - 208V <b>3</b> - 240V <b>4</b> - 277V <b>5</b> - 347V	<b>R5</b> - glass refractor IES V <b>R3</b> - glass refractor IES III <b>LV</b> - louver stack IES V	<b>SF</b> - single fuse <b>DF</b> - double fuse <b>BP</b> - button photocell <b>LP</b> - locking photocell	<b>GRN</b> - green <b>BRZ</b> - bronze <b>GRY</b> - grey <b>WHT</b> - white <b>CBA</b> - custom
	<b>S</b> - small 16"OD	<b>CP</b> clear polycarbonate <b>WP</b> white polycarbonate	 <b>H</b> 8" H  <b>K</b> 11" H					

Suggested pole and bracket combinations

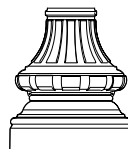

SP01

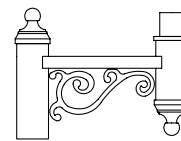

SA501-A

**Sheridan**  
lighting systems, inc.