

SA50

Specifications

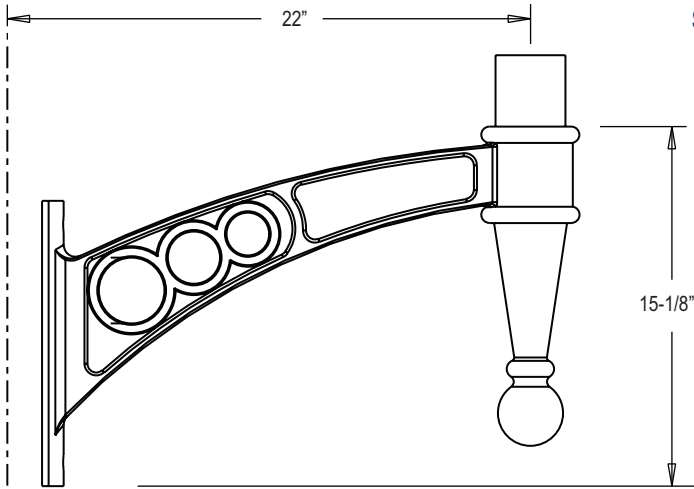

SA50-A

The arm shall be SA50-_____ (specify configuration) arm, consisting of cast aluminum arm(s) clamping onto a pole shaft. Wall brackets shall be welded to a cast aluminum wall plate.

The arm shall be a one piece casting with a decorative finial. All hardware shall be tamper resistant, stainless steel.

A variety of configurations is available, some of which are illustrated on this page. Non-standard configurations may be feasible, please consult factory for details.

Post top arms shall clamp onto a 4" OD pole shaft. Arms shall be equipped with 3"OD x 3"H tenons. Mounting hardware not included.

SA50

Arm	Layout	Color
-----	--------	-------

- A** - single at 90°
- B** - twin at 180°
- BC** - twin at 180° plus central
- C** - triple at 120°
- CC** - triple at 120° plus central
- D** - quad at 90°
- E** - quad at 90° plus central
- BLK** - black
- GRN** - green
- BRZ** - bronze
- GRY** - grey
- WHT** - white
- CTM** - custom

SA50

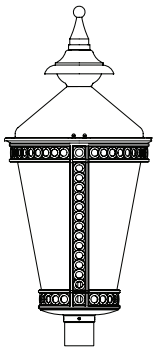

SH40

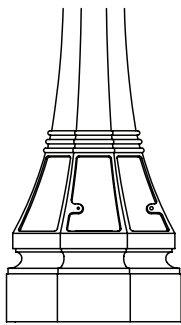

SP05



*The Venetian Resort Hotel Casino
Las Vegas, NV*

Suggested pole and luminaire combinations

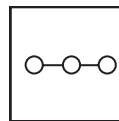

SA50-BC

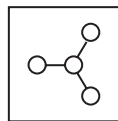

SA50-CC

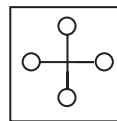

SA50-D

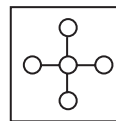

SA50-E

Sheridan
lighting systems, inc.